

Indice generale

<i>1 Architravi in cemento</i>	<i>pag.2</i>	<i>17 coperchi tipo leggero</i>	<i>pag 13</i>
<i>2 Architravi in cotto</i>	<i>pag 2</i>	<i>18 coperchi t/leggero con botola</i>	<i>pag 13</i>
<i>3 Anelli perdenti</i>	<i>pag.3</i>	<i>19 coperchi t/leggero con griglia</i>	<i>pag 14</i>
<i>4 Coperchi rotondi</i>	<i>pag 3</i>	<i>20 coperchi traffico medio/pesante c/botola</i>	<i>pag 14</i>
<i>5 Biologica in cemento d.60</i>	<i>pag 4</i>	<i>21 coperchi t/rinforzato pesante d400</i>	<i>pag15</i>
<i>6 Biologica in cemento d.80</i>	<i>pag 4</i>	<i>22 pozzetto in cemento tipo firenze</i>	<i>pag 15</i>
<i>7 biologica in cemento d.100</i>	<i>pag 5</i>	<i>23 pozzetti prefabbricati per acquedotto</i>	<i>pag 16</i>
<i>8 fossa imhoff d.80</i>	<i>pag 5</i>	<i>24 plinti in cem. Di sostegno e parapetto</i>	<i>pag 16</i>
<i>9 fossa imhoff d.110</i>	<i>pag 6</i>	<i>25 piastre in cemento vibrato e armate</i>	<i>pag 17</i>
<i>10 fossa imhoff d.125</i>	<i>pag 6</i>	<i>26 manufatti in C.a. per loculi</i>	<i>pag 18</i>
<i>11 blocchi in cemento</i>	<i>pag 7</i>	<i>27 recinzioni con pannelli gettati lisci</i>	<i>pag 19</i>
<i>12 Bocche da lupo in cemento gettato con griglie</i>	<i>pag 8</i>	<i>28recinzioni in c.a. per ferrovia</i>	<i>pag 20</i>
<i>13 canalette in cemento gettato</i>	<i>pag 9</i>	<i>29 perfili ornamentali</i>	<i>pag 21</i>
<i>14 canalette in cemento</i>	<i>pag 10</i>	<i>30 porta contatori enel</i>	<i>pag 22</i>
<i>15 pozzetti in cemento normale</i>	<i>pag 11</i>	<i>31 basi per fognovoltaico</i>	<i>pag 23</i>
<i>16 prolunghe in cemento normale</i>	<i>pag 12</i>	<i>32 betonblok</i>	<i>pag 23</i>
		<i>33 basamenti x gru</i>	<i>pag 24</i>

1 Architravi in cemento

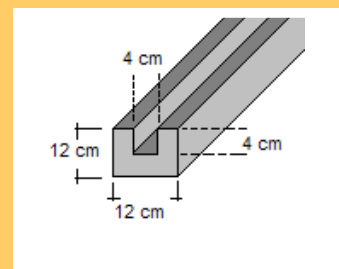

<i>codice</i>	<i>Lunghezza cm</i>	<i>Spessore cm</i>	<i>Peso kg</i>	<i>Pz Conf.</i>	<i>prezzo</i>
ARCH100	100	12x12	30	32	
ARCH120	120	12x12	36	32	
ARCH140	140	12x12	42	32	
ARCH160	160	12x12	48	32	
ARCH180	180	12x12	54	32	
ARCH200	200	12x12	60	24	
ARCH220	220	12x12	66	24	
ARCH240	240	12x12	72	24	
ARCH260	260	12x12	78	24	
ARCH280	280	12x12	84	24	
ARCH300	300	12x12	90	24	
ARCH400	400	12x12	110	16	

2 Architravi in cotto

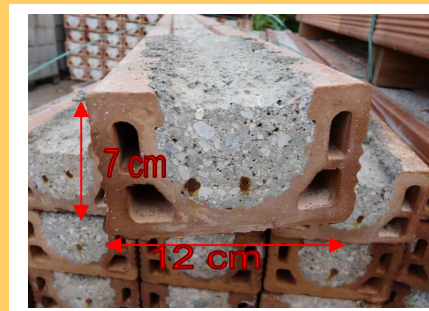

<i>codice</i>	<i>Lunghezza cm</i>	<i>Spessore cm</i>	<i>Peso kg</i>	<i>Pz Conf.</i>	<i>prezzo</i>
ARCHC100	100	12x7	16	54	
ARCHC125	125	12x7	20	54	
ARCHC150	150	12x7	24	54	
ARCHC175	175	12x7	28	54	
ARCHC200	200	12x7	32	54	
ARCHC225	225	12x7	36	54	
ARCHC250	250	12x7	40	36	
ARCHC275	275	12x7	44	36	
ARCHC300	300	12x7	48	36	

3 Anelli perdenti

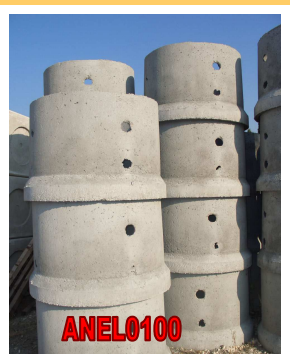

<i>Codice</i>	<i>Misure interne</i> <i>cm</i>	<i>Misure esterne</i> <i>cm</i>	<i>Altezza</i> <i>cm</i>	<i>Spessore</i> <i>cm</i>	<i>Peso kg</i>	<i>prezzo</i>
ANEL080	080 c/bicch	90	50	5	190	
ANEL0100.1	100 s/bicch	110	50	5	210	
ANEL0100	100 c/bicch	112	80	6	400	
ANEL0110	110	120	50	5	250	
ANEL0125	125	135	50	5	300	
ANEL0150	150 c/incastro	165	50	6	380	
ANEL0200	216 c/incastro	238	50	6	550	
ANEL0200F	200 c/incastro	216	50	8	780	

Tutti gli anelli si possono avere anche senza fori

4 Coperchi rotondi



<i>Codice</i>	<i>Misure interne</i> <i>cm</i>	<i>Misure esterne</i> <i>cm</i>	<i>Spess</i> <i>cm</i>	<i>Descriz.</i> <i>tappo</i>	<i>Peso</i> <i>kg</i>	<i>prezzo</i>
CP060L	Leggero d.60	70	8	1 tappo 30x30	50	
CP060R	Rinforzato d.60	70	8	1 tappo 30x30	50	
CP080L	Leggero d. 80	90	8	1 tappo 30x30	110	
CP080R	Rinforzato d.80	90	12	1 tappo 30x30	180	
CP100L	Leggero d.100	110	8	1 tappo 30x30	180	
CP100R	Rinforzato d.100	110	12	1 tappo 30x30	270	
CP110L	Leggero d. 110	120	8,5	2 tappi 30x30	200	
CP110R	Rinforzato d.110	120	15	2 tappi 30x30	400	
CP125L	Leggero d. 125	140	10	2 tappi 30x30	320	
CP125R	Rinforzato d.125	140	15	2 tappi 30x30	500	
CP150R	Rinforzato d.150	170	15	1 tappo d. 60	780	
CP200R	Rinforzato d.200	238	20	1 tappi d. 60	1450	

5 Biologica in cemento d. 60



<i>Codice</i>	<i>Articolo</i>	<i>altezza cm</i>	<i>N utenti</i>	<i>Peso kg</i>	<i>Pz Confez.</i>	<i>prezzo</i>
BIOL0060	Biologica in cemento d. 60 interno s/coperchio.	100	4	250	sfusi	
ANELBIO60	Anello biologica d. 60	50		120	Sfusi	
CP060L	Coperchio legg. d. 60 (70 est) con ispezione centrale	8		50	Sfusi	
CP060R	Coperchio rinf d. 60 (70 est) con ispezione centrale	8		50	Sfusi	

6 Biologica in cemento d. 80

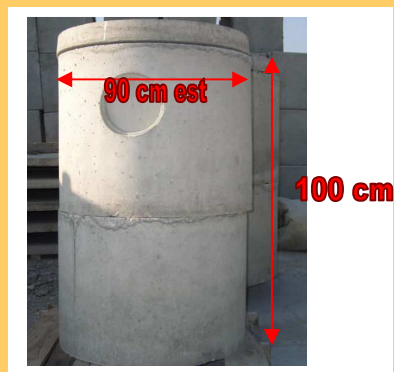

<i>Codice</i>	<i>Articolo</i>	<i>altezza cm</i>	<i>N utenti</i>	<i>Peso kg</i>	<i>Pz Confez.</i>	<i>prezzo</i>
BIOL0080	Biologica in cemento d. 80 interno s/coperchio	100	8	500	sfusi	
ANELBIO80	Anello biologica d. 80	50		250	Sfusi	
CP080L	Coperchio legg. d. 80 (90 est) con ispezione centrale	8		110	Sfusi	
CP080R	Coperchio rinf d. 80 (90 est) con ispezione centrale	12		180	Sfusi	

7 Biologica in cemento d. 100



<i>Codice</i>	<i>Articolo</i>	<i>altezza cm</i>	<i>N utenti</i>	<i>Peso kg</i>	<i>Pz Confez.</i>	<i>prezzo</i>
BIOL0100	Biologica in cemento d. 100 interno s/coperchio	100	12	630	sfusi	
ANELBIO100	Anello biologica d.100	50		300	Sfusi	
CP100L	Coperchio legg. d. 100 (110 est)	8		180	Sfusi	
CP100R	Coperchio rinf d. 100 (110 est)	12		270	Sfusi	

8 Fossa imhoff d. 80

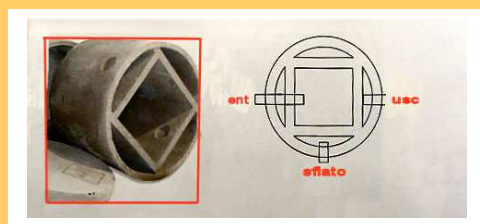

<i>Codice</i>	<i>Articolo</i>	<i>altezza cm</i>	<i>N utenti</i>	<i>Peso kg</i>	<i>Pz Confez.</i>	<i>prezzo</i>
FIMC80	Fossa imhoff 80 x 150 s/coperchio	150	4	963	sfusi	
CP080L	Coperchio legg. d. 80 (90 est) con ispezione centrale	8		110	Sfusi	
CP080R	Coperchio rinf d. 80 (90 est) con ispezione centrale	12		180	Sfusi	

9 Fossa imhoff d. 110

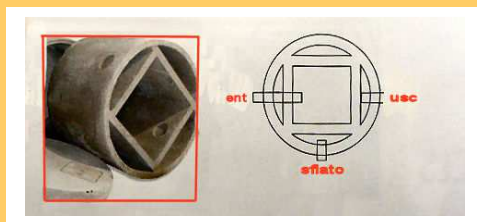

<i>Codice</i>	<i>Articolo</i>	<i>altezza cm</i>	<i>N utenti</i>	<i>Peso kg</i>	<i>Pz Confez.</i>	<i>prezzo</i>
FIMC110	Fossa imhoff 110 s/coperchio	140	7	1450	sfusi	
CP110L	Coperchio legg. d. 110 (120 est) con ispezione centrale	8,5		200	Sfusi	
CP110R	Coperchio rinf d. 110 (120 est) con ispezione centrale	15		400	Sfusi	

10 Fossa imhoff d.125

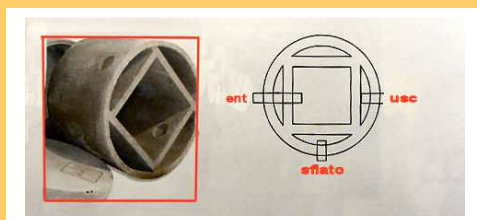

<i>Codice</i>	<i>Articolo</i>	<i>altezza cm</i>	<i>N utenti</i>	<i>Peso kg</i>	<i>Pz Confez.</i>	<i>prezzo</i>
FIMC125	Fossa imhoff 125 s/coperchio	195	12	2200	sfusi	
CP125L	Coperchio legg. d. 125 (140 est) con ispezione centrale	10		300	Sfusi	
CP125R	Coperchio rinf d. 125 (140 est) con ispezione centrale	15		500	Sfusi	

11 Blocchi in cemento

<i>Codice</i>	<i>articolo</i>	<i>Misure esterne</i> <i>L P H cm</i>	<i>R.E.I.</i>	<i>Peso kg</i>	<i>Pz</i> <i>banc.</i>	<i>prezzo</i>
 BLC1340	Blocco 13 2F	13x20x40	No	12	111	
 BLC2040	Blocco 20 4F	20x20x40	No	18	75	
 BLC2540	Blocco 25 4F	25x20x40	No	23	63	
 BLCINT8	Blocco 8 4F intonaco	8x20x50	30	11	120	
 BLC1250.INT	Blocco 12 4F intonaco	12x20x50	30	13	80	
 BLC1250	Blocco 12 facciavista	12x20x50	120	16	80	
 BLC20.SPLIT	Blocco 20 S splittato	20x20x50	90	21	50	
 BLC20C	Blocco cassero 20	20x20x50	No	17	70	
 BLC25C	Bocco cassero 25	25x20x50	No	21	56	
 BLC30C	Blocco cassero 30	30x20x50	No	25	42	
Altre forme e colori a richiesta						

12 Bocche da lupo in cemento gettato con griglie

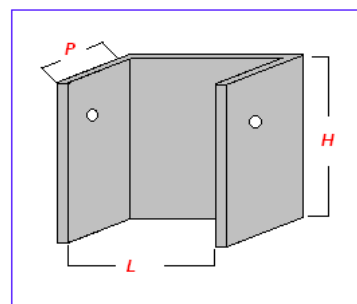
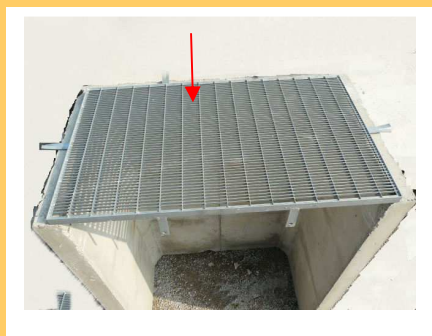

<i>Codice</i>	<i>Misure interne</i> <i>L H P cm</i>	<i>Misure esterne</i> <i>L H P cm</i>	<i>Spessore</i> <i>cm</i>	<i>Peso</i> <i>kg</i>	<i>Pz</i> <i>Confez.</i>	<i>prezzo</i>
BOCL100	100x150x60	118x150x70	8,5/10	710	1	
BOCL125	125x150x60	143x150x70	8,5/10	800	1	
BOCL140	140x150x60	158 x150x70	8,5/10	850	1	
BOCL150	150x150x60	168 x150x70	8,5/10	890	1	
BOCL175	175x150x60	193 x150x70	8,5/10	980	1	
BOCL200	200x150x60	218 x150x70	8,5/10	1020	1	
BOCL220	220x150x60	238 x150x70	8,5/10	1080	1	
BOCL250	250x150x60	268 x150x70	8,5/10	1180	1	
Le misure altezza e larghezza si possono modificare						
520.BL106	Griglie zincate Senza Telaio pressate a norme DIN24537 piatto portante 25x2 con zanche x fissaggio a muro maglia 66x11 ANTITACCO Idonea classe 1 (portata pedonale)	106x63	3		1	
520.BL131		131x63	3		1	
520.BL146		146x63	3		1	
520.BL156		156x63	3		1	
520.BL181		181x63	3		1	
Altre misure e modelli a richiesta						

13 Canalette in cemento gettato



000
ZZZ 100015
000 100020
000 100025



CN.SMART150
CN.SMART200



<i>Codice</i>	<i>Misure esterne</i> <i>cm</i>	<i>Misure incastro</i> <i>griglia</i> <i>cm</i>	<i>Peso</i> <i>kg/mt</i>	<i>Pz</i> <i>Confez.</i>	<i>prezzo</i>
CN10015 520.10015	Canaletta 100x21x19 Griglia zincata 100x15 B125	15x2,5 15x2,5	75	16	
CN10020 520.10020	Canaletta 100x24x27 Griglia zincata 100x20 B125	20x2,5 20x2,5	105	16	
CN10025 520.10025	Canaletta 100x34x31 Griglia zincata 100x25 B125	25x2,5 25x2,5	150	9	
CN.SMART100	Canaletta 100x18x17 L zinc completa di griglia in ghisa cl 250	15x2,5	38	35	
CN.SMART150	Canaletta 100x21x22 L zinc completa di griglia in ghisa cl 250	20x2,5	46	20	
CN.SMART200	Canaletta 100x26x29 L zinc completa di griglia in ghisa cl 250	25x2,5	76	20	
CN1003331 773.31535	Canaletta Pircher T/200 100x33x31 + 2 Griglia in ghisa D400	33 33	200		
CN050 GRC5025	Canaletta Piscina 50x31x35 Griglia cemento 50x25	25x2 50x35x2			

14 Canalette in cemento

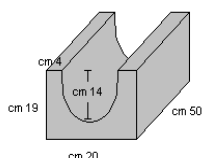

CN502020

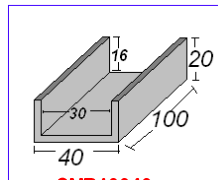

CNP10040

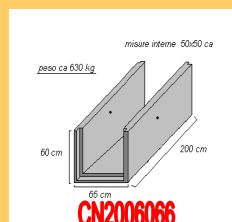

CN2006066

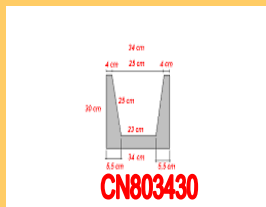

CN803430

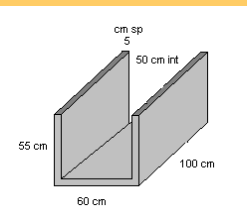

CN1006055



CNFV100175

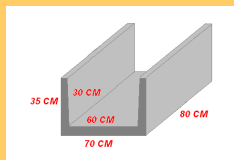

CN807035

Codice	Misure esterne cm	Misure interne cm	Spessore cm	Peso kg	Pz Confez.	prezzo
CN502020	Canaletta a U T/L 50x20x20	50x15x15	3	25	1	
CNP10040	Canaletta passacavo 100x40x20	100x30x16	4	70	1	
CNPC10040	Coperchio x canale 100x40x5		5	45	1	
CN1006055	Canale 100x60x55	100x50x50	5	200	1	
CN.080ZB	Canale CLS POLIMERICO 100X5,5	100x10x5,5	5		1	
CN.080B	Canale CLS POLIMERICO 100X9,7	100x10x9,7				
CN807035	Canale 80x70x35	80x60x30	5	140	1	
CN803430	Canale 80x34x30	80x25x25	5,5/4	73	1	
Altre misure a richiesta del cliente						

15 Pozzetti in cemento normali

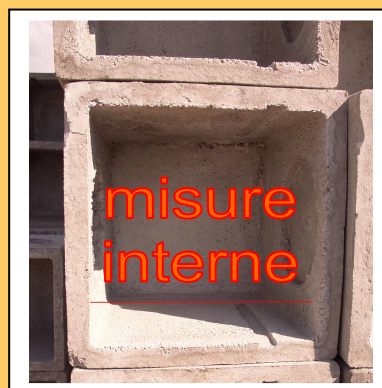

<i>Codice</i>	<i>Misure interne cm</i>	<i>Altezza cm</i>	<i>Spessore cm</i>	<i>Peso kg</i>	<i>Pz Confez.</i>	<i>prezzo</i>
PZ2020	20x20	20	3	22		
PZ2525	25x25	25	3	34		
PZ3030	30x30	33	3	46		
PZ4040	40x40	44	4	80		
PZ5050	50x50	54	4	135		
PZ6060	60x60	65	5	235		
PZ8080	80x80	85	5	460		
PZ100100	100x100	107	7	960		

16 Prolunghe in cemento normali

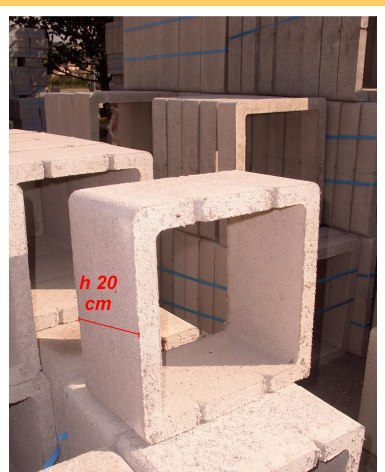

<i>Codice</i>	<i>Misure interne</i> <i>cm</i>	<i>Altezza</i> <i>cm</i>	<i>Spessore</i> <i>cm</i>	<i>Peso kg</i>	<i>Pz</i> <i>Confez.</i>	<i>prezzo</i>
PR2020	20x20	20	3	20		
PR2525	25x25	25	3	30		
PR3010	30x30	10	3	15		
PR3020	30x30	20	3	25		
PR3030	30x30	33	3	35		
PR4010	40x40	10	4	18		
PR4020	40x40	20	3	35		
PR4040	40x40	44	3	65		
PR5010	50x50	10	5	35		
PR5020	50x50	20	5	48		
PR5050	50x50	55	5	135		
PR6010	60x60	10	5	45		
PR6020	60x60	20	5	65		
PR6060	60x60	65	5	210		
PR8020	80x80	20	6	120		
PR8080	80x80	84	6	400		
PR100100	100x100	105	7	800		
PR10050	100x100	55	7	400		

17 Coperchi tipo leggero

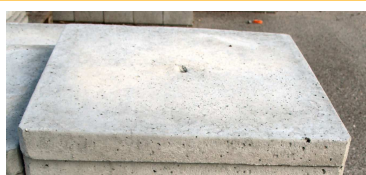

**piastra unica
con foro centrale**

<i>Codice</i>	<i>Misure interne Rif. pozzetto</i>	<i>Misure esterne cm</i>	<i>Spessore cm</i>	<i>Peso kg</i>	<i>Pz Confez.</i>	<i>prezzo</i>
CPN20	20x20	24x24	3	5	Sfusi	
CPN25	25x25	30x30	3	9	Sfusi	
CPN30	30x30	36x36	4	12	Sfusi	
CPN40	40x40	47x47	4	20	Sfusi	
CPN50	50x50	58x58	4	35	Sfusi	
CPN60	60x60	69x69	5	50	Sfusi	
CPN80	80x80	90x90	9	170	Sfusi	

18 Coperchi tipo leggero c/botola



<i>Codice</i>	<i>Misure interne Rif. pozzetto</i>	<i>Misure esterne cm</i>	<i>Spessore cm</i>	<i>Peso kg</i>	<i>Pz Confez.</i>	<i>prezzo</i>
CPL25	25x25	30x30	5	11		
CPL30	30x30	40x40	7	18		
CPL40	40x40	49x49	8	32		
CPL50	50x50	60x60	9	48		
CPL60	60x60	70x70	9	65		
CPL80	80x80	92x92	9	170		
CPL100	100x100	115x115	9	300		

19 Coperchi tipo leggero con griglia

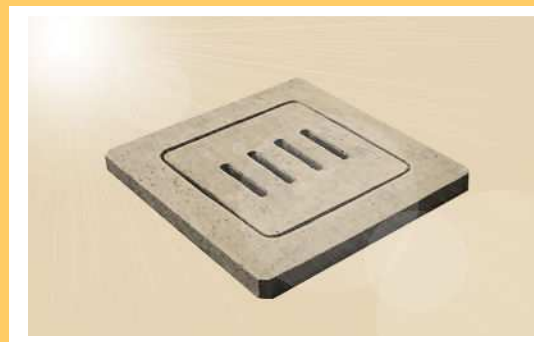

Codice	Misure interne Rif. pozzetto	Misure esterne cm	Spessore cm	Peso kg	Pz Confez.	prezzo
CPG30	30x30	40x40	5	18	Sfusi	
CPG40	40x40	49x49	7	32	Sfusi	
CPG50	50x50	60x60	8	48	Sfusi	
CPG60	60x60	70x70	9	65	Sfusi	

20 Coperchi traffico medio pesante c/botola

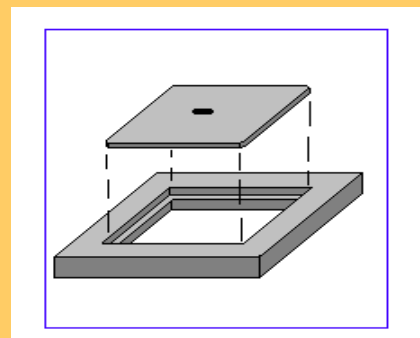

Codice	Misure interne Rif. pozzetto	Misure esterne cm	Spessore cm	Peso kg	Pz Confez.	prezzo
CPR30	30x30	40x40	9	29		
CPR40	40x40	50x50	10	53		
CPR50	50x50	60x60	10	80		
CPR60	60x60	70x70	11	105		
CPR080	80x80	92x92	14	300		
CPR0100	100x100	120x120	14	500		

21 Coperchi tipo rinforzato traffico pesante D400



<i>Codice</i>	<i>Misure esterne cm</i>	<i>Spessore cm</i>	<i>Misura foro quadrato interno cm</i>	<i>Peso kg</i>	<i>Pz Confez.</i>	<i>prezzo</i>
PS160	Coperchio 160x160	20	60x60	1080	sfusi	

22 pozzetto in cemento tipo firenze

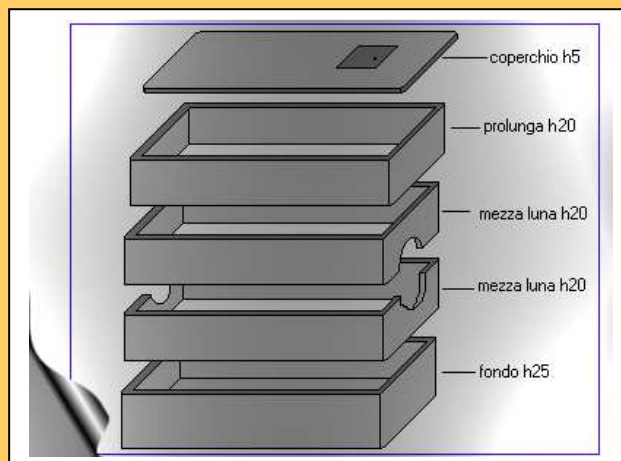

<i>Codice</i>	<i>Misure interne cm</i>	<i>Altezza cm</i>	<i>Spessore cm</i>	<i>Peso kg</i>	<i>Pz Confez.</i>	<i>prezzo</i>
PRN4080	40x80 normale	20	5	57	12	
PRL4080	40x80 ½ luna	20	5	54	12	
CPN4080	40x80 normale		5	38	10	
CPS4080	40x80 c/ispezione		5	38	10	

23 Pozzetti prefabbricato acquedotto



Codice	Misure esterne cm	Altezza cm	Spessore cm	Peso kg	Pz Confez.	prezzo
PZA70	Pozzetto 70x70	60		200	5	
CPLA70	Coperchio leggero in cem 70x70 con botola in f/zincata		6	65	10	
CPRA70	Coperchio rinforzato in cem 70x70 con botola in f/zincata		10	100	5	
CPA40	Anelli sovrapponibili d.30 acqua gas	10		20	100	

24 Plinti in cemento da sostegno e da parapetto

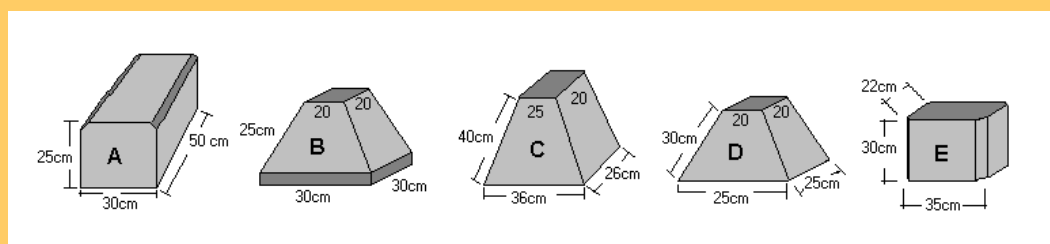

Codice	Articolo	Misure esterne cm	Spessore cm	Peso kg	Pz Confez.	prezzo
PLINT001	Plinto A	50x30x25		90	Sfusi	
PLINT002	Plinto B	30x30x25		45	Sfusi	
PLINT003	Plinto C	25x35x40		73	Sfusi	
PLINT004	Plinto D	25x25x30		41	Sfusi	
PLINT005	Plinto E	25x35x30		58	Sfusi	

Altre misure a richiesta

25 *Piastre in cemento vibrato e armate*



<i>Codice</i>	<i>Lunghezza</i> <i>cm</i>	<i>Larghezza</i> <i>cm</i>	<i>Spessore</i> <i>cm</i>	<i>Peso</i> <i>kg</i>	<i>Pz</i> <i>Confez.</i>	<i>prezzo</i>
PSL10025	100	25	4	24	50	
PSL10030	100	30	4	29	40	
PSL10035	100	35	4	33	36	
PSL10040	100	40	4	38	30	
PSL10050	100	50	4	48	25	

Altre misure e spessori a richiesta

26 manufatti in C.A. per loculi

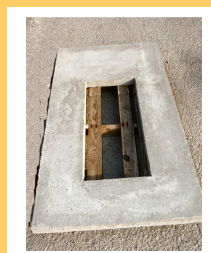
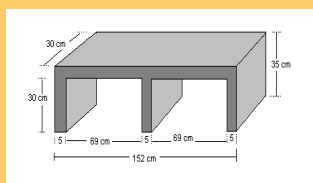

Codice	Misure esterne	Misure interne	Spessore cm	Peso kg	Pz Confez.	prezzo
PS2422	Sigillo ossario 24x22		2,00	3	50	
PS6975	Sigillo loculo 69x75		2,20	24	30	
PS6772	Sigillo loculo 67x72		2,20	24	30	
OSS.01	Ossario a pettine 150x30x35	70/70x30x30	5	90	1	
PS19085	Piastra sostegno lapide 190x85 c/foro centrale	140x45	5	120	1	
PS13070	Piastra sostegno lapide 130x70 c/foro centrale	70x30	5	80	1	
PS25080	Piastra x lapide h25x80		4,5	21,5	1	
PS25100	Piastra x lapide h25x100		4,5	27	1	
PS25120	Piastra x lapide h25x120		4,5	32,5	1	
PS25140	Piastra x lapide h25x140		4,5	38	1	
PS25160	Piastra x lapide h25x160		4,5	43	1	
PS25180	Piastra x lapide h25x180		4,5	48,5	1	
PS25200	Piastra x lapide h25x200		4,5	54	1	
PS30080	Piastra x lapide h30x80		5	28	1	
PS30100	Piastra x lapide h30x100		5	35	1	
PS30120	Piastra x lapide h30x120		5	42	1	
PS30140	Piastra x lapide h30x140		5	49	1	
PS30160	Piastra x lapide h30x160		5	56	1	
PS30180	Piastra x lapide h30x180		5	63	1	
PS30200	Piastra x lapide h30x200		5	70	1	
PS30220	Piastra x lapide h30x220		5	77	1	
PS30240	Piastra x lapide h30x240		5	84	1	
PS35100	Piastra x lapide h35x100		5	42	1	
PS35200	Piastra x lapide h35x200		5	84	1	
PS35240	Piastra x lapide h35x240		5	100	1	
PS35280	Piastra x lapide h35x280		5	118	1	

Altre misure e spessori a richiesta

27 Recinzioni con pannelli gettati lisci

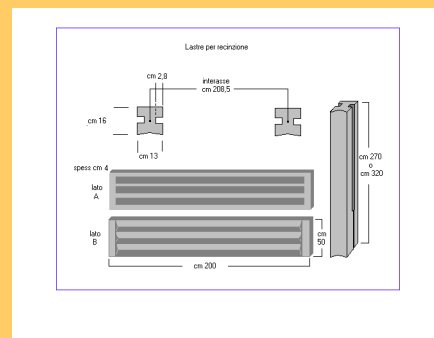

Codice	Articolo	altezza cm	Spessore cm	Peso kg	Pz Confez.	prezzo
PRECN270	Palo per lastra da recinzione	270	13x16	130	12	19,00
PRECN320	Palo per lastra da recinzione	320	13x16	160	12	22,50
LSN20050	Lastra da recinzione	200Lx50H	4	80	20	13,95
Altre misure del palo a richiesta						

28 Recinzioni in C.A. per ferrovia

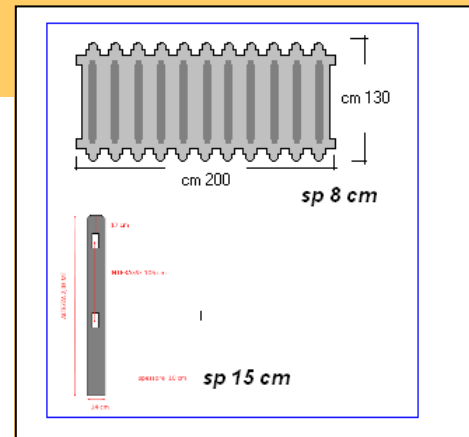

Codice	Misure cm	Spessore cm	Peso kg	Pz Confez.	prezzo
PRECFS200	Palo per ferrovia h 200x21	15	60	20	
LSFS200	Lastra per ferrovia L 200x130 h	8	120	10	

29 *Perfili ornamentali*



PF10011

PF10012



PF10013



PF10014



PF10015

PF10016



PF10017



PF10019

<i>Codice</i>	<i>modello</i>	<i>Lunghezza</i> <i>cm</i>	<i>altezza</i> <i>cm</i>	<i>Sp</i> <i>cm</i>	<i>Peso</i> <i>kg</i>	<i>Pz</i> <i>Confez</i>	<i>prezzo</i>
PF10011	Modello onda	100	31	4	29,5	30	
PF10012	Modello rosa	100	40	4	38,4	30	
PF10013	Modello conchiglia	100	35	4	33,6	30	
PF10014	Modello treccia	100	27	4	26	30	
PF10015	Modello ruota	100	30	4	28,8	30	
PF10016	Modello vimini	100	27	4	26	30	
PF10017	Modello cappetta	100	31	4	29,5	30	
PF10019	Modello liscio smussato	100	25	4	24	30	

Altre misure e spessori a richiesta

30 Porta contatori enel in cemento

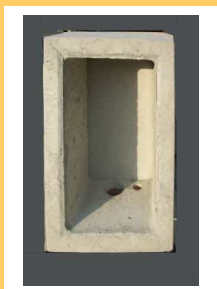

industriale



Codice	modello	Dimensioni in cm						Spes cm	Peso kg	prezzo
		Lunghezza		altezza		profond				
		int	est	int	est	int	est			
PCONE020	Porta-contatori enel singolo	25	37	45	57	23	26	6	68	
PCONE021	Porta-contatori enel singolo con colonna	25	37	45	<u>115</u>	23	26	6	150	
PCONE022	Porta-contatori enel doppio	40	54	45	57	25	29	6	90	
PCONE023	Porta-contatori enel doppio con colonna	40	54	45	<u>115</u>	25	29	6	190	
PCONE024	Porta contatori enel industriale	90	102	110	122	30	35	6	320	
Per altre misure chiedere informazioni										

31 basi per fotovoltaico

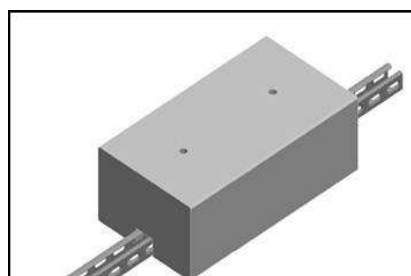
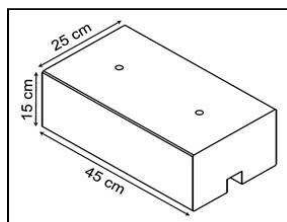
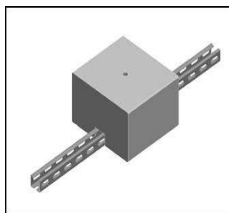
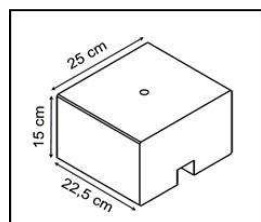

Codice	modello	Dimensioni in cm			Peso kg	Pz Conf	prezzo
		Lunghez	Largh.	altezza			
FT.01	Basi per fotovoltaico	22,5	25	15	20		
FT.02	Basi per fotovoltaico	45	25	15	40		
Per altri disegni chiedere informazioni							

32 BETONBLOCK

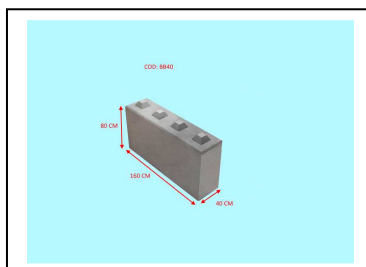
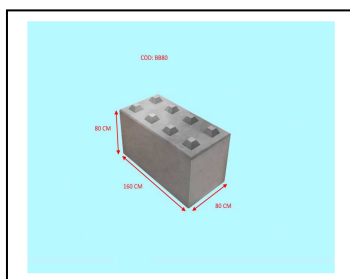

Codice	modello	Dimensioni in cm			Peso kg	Pz Conf	prezzo
		Lunghez	Largh.	altezza			
BB40	BETONBLOCK 160X80 SP.40	160	40	80	1200		
BB80	BETONBLOCK 160X80 SP.80	160	80	80	2400		
BB40M	BETONBLOCK 80X80 SP.40	80	40	80	600		
BB80M	BETONBLOCK 80X80 SP.80	80	80	80	1200		
Per altri disegni chiedere informazioni							

33 BASAMENTI PER GRU

<i>Codice</i>	<i>modello</i>	<i>Dimensioni in cm</i>			<i>Peso kg</i>	<i>Pz Conf</i>	<i>prezzo</i>
		<i>Lunghez</i>	<i>Largh.</i>	<i>altezza</i>			
ZAV10020	PIASTRE BASAMENTO 100X100X20	100	100	20			
ZAV12024	PIASTRE BASAMENTO 120X120X24	120	120	24			
ZAV15028	PIASTRE BASAMENTO 150X150X28	150	150	28			